

DF

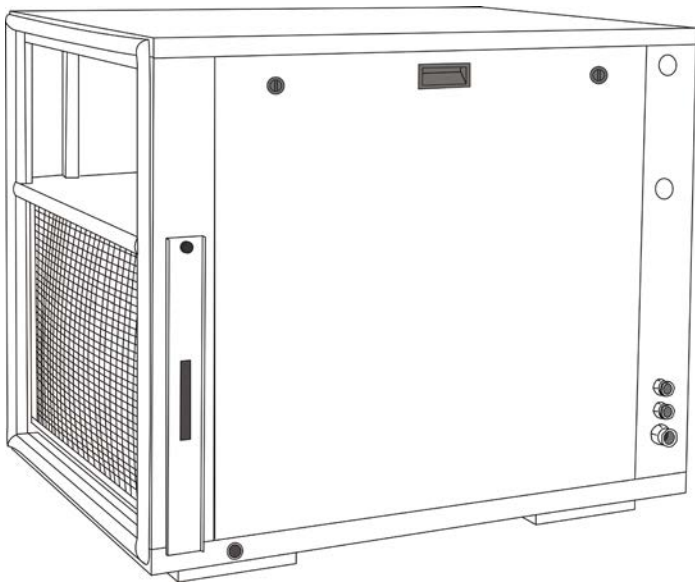

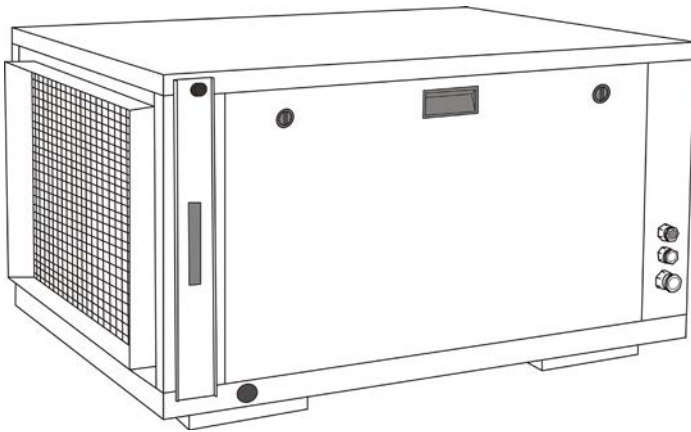

Instructions for installation and use
English

EN

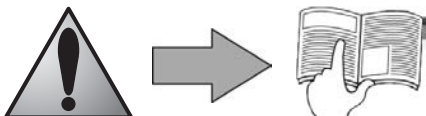

More documents on:
www.zodiac-poolcare.com



- Read this manual carefully before installing, maintaining or repairing this appliance!
- The symbol  indicates important information that must be taken into account in order to avoid risk of personal injury and/or damage to the appliance.
- The symbol  indicates useful information.



Warnings

- As part of a continuous improvement process our products may be modified without prior notice.
- Exclusive use: for dehumidifying swimming pool premises (must not be used for any other purpose),
- This device must be installed and serviced by certified professionals approved in the electrical, hydraulic and cooling domains,
- The appliance must be installed by a qualified technician in compliance with the manufacturer's instructions and with applicable local standards. The installer is liable for the installation of the appliance and the compliance with local regulations in matters of installation. Under no circumstances can the manufacturer be held liable in the event of failure to comply with applicable local standards.
- Wrong installation may cause serious damage to property or serious injuries (possibly causing death).
- It is important that this equipment is operated by competent and qualified (both physically and mentally) people who have previously received the instructions for use (by reading this manual). All persons not meeting these criteria must not approach the appliance in order to avoid exposure to dangerous elements.
- If the appliance suffers a malfunction, do not try to repair the appliance yourself, contact your reseller.
- Before carrying out any operation on the machine, check that the power supply is cut and that the machine is tagged out,
- Before all connections, make sure that the voltage indicated on the maker's plate of the appliance corresponds to the mains voltage.
- Eliminating or shunting one of the safety devices automatically voids the warranty, as does the replacement of parts using parts not manufactured by ourselves.
- Keep the appliance out of the reach of children.
- Do not discharge R407C fluid into the atmosphere: R407C is a fluorinated greenhouse effect gas, covered by the Kyoto Protocol, with a Global Warming Potential (GWP) = 1653 - (Directive EC 842/2006).
- According to French decree no. 2007-737 of 7th May 2007, if the appliance has more than 2 kg of refrigerant gas (refer to manufacturer specifications), the cooling circuit must be checked for leakage at least once a year. This operation must be carried out by a certified cooling appliance specialist.

Additional recommendations in relation to the Pressure Equipment Directive (PED-97/23/EC)

1. Installation and maintenance

- The unit may not be installed close to combustible materials, or the air duct inlet of an adjacent building .
- With some devices, it is essential to fit protection grids if the unit is installed in an area with uncontrolled access.
- During installation, troubleshooting and maintenance, pipes may not be used as steps: the pipe could break under the weight, spilling refrigerant and possibly causing serious burns.
- When servicing the appliance, the composition and state of heat carrying fluid must be checked, as well as the absence of any refrigerant.
- During the annual unit sealing test in accordance with applicable legislation, the high and low pressure switches must be checked to ensure that they are securely fastened to the coolant circuit and that they cutoff the electrical circuit when tripped.
- During maintenance work, ensure there are no traces of corrosion or oil around cooling components.
- Before beginning work on the cooling circuit, stop the device and wait for a few minutes before fitting the temperature and pressure sensors. Some elements such as the compressor and piping may reach temperatures in excess of 100°C and high pressures with the consequent risk of severe scalding.

2. Troubleshooting

- All soldering work must be carried out by a someone qualified to do so.
- Replacement pipes must always be made of copper in compliance with standard NF EN 12735-1.
- Leak detection; pressure test:
 - never use oxygen or dry air, risk of fire or explosion,
 - use dry nitrogen or the mixture of nitrogen and refrigerant indicated on the information plate,
 - the test pressure for both the high and low pressure circuits must not exceed 20 bar and 15 bar in the case the device is equipped of the manometer option.
- The high pressure circuit pipes are made of copper and have a diameter equal to or greater than 1''5/8. A certificate as indicated in §2.1 in compliance with standard NF EN 10204 will be requested from the supplier and filed in installation technical documentation.
- Technical data relative to the safety requirements of the various applicable directives must be indicated on the information plate.
- All this information must be recorded in the unit's installation manual, which must be kept in the technical file of the unit: model, code, serial number, maximum and minimum OT, OP, year of manufacture, EC label, manufacturer's address, refrigerant and weight, electrical parameters, thermo-dynamic and acoustic performances

Contents

1. Information before installing	3
1.1 General delivery terms and conditions	3
1.2 Contents	3
1.3 Technical specifications	3
2. Installation	4
2.1 Installation requirements	4
2.2 Connection of the condensation drainage	4
2.3 Connection to a duct network for DF ducted	5
2.4 Inset connection for DF inset	6
2.5 Electric connections	7
2.6 Connecting the options	10
3. Use	11
3.1 Start the appliance	11
3.2 Checks	11
3.3 Adjusting the duct network (only on ducted DF)	11
3.4 Options starting up	11
4. Maintenance	12
4.1 Maintenance instructions	12
4.2 Spare parts	13
4.3 Recycling	13
5. Troubleshooting	13
5.1 Status and faults in the ECP600 settings	13
5.2 FAQ	14
6. Registering the product	14



Available in the appendices at the end of this manual:

- Electrical diagram
- Dimensions
- CE declaration of conformity

1. Information before installing







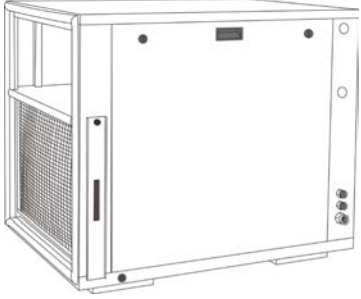
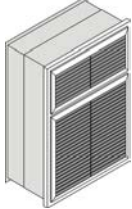

1.1 General delivery terms and conditions

All equipment, even postage and packing paid, travels at the risks and perils of the recipient. The consignee shall make reservations in writing on the carrier's bill of lading if damage is detected, caused during transport (confirmation to be sent to the carrier within 48 hours by registered mail with acknowledgement of receipt).

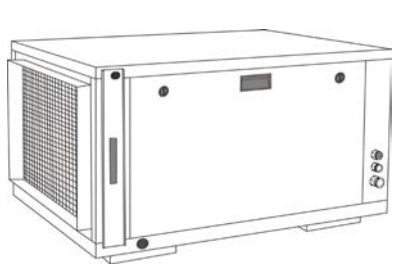
The device must be transported and stored upright on its pallet in its original packaging.

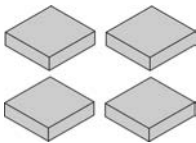
If the device has been turned on its side, mention your reservations in writing to the carrier.

1.2 Contents

			or		
DF Inset	Part for sealing with frame + grids	Wall-fixing square			DF sheath
x1	x1	x2			x1
					
Hygro Control	Anti-vibration studs	Half union Ø32 connector to glue + PVC fitting 1" + joint	With condenser option: half union Ø50 connector to glue + joints	With hot water battery option: Ø20/22 bush to solder + joints	
x1	x4	x1	x2	x2	

1.3 Technical specifications

Appliance	Dehumidifying capacity*	Power consumed*	Power restored on the ambient air*	Available pressure**	Air flow rate
Without option	L/h	W	W	mmCE	m ³ /h
DF403	3.5	1,500	3,600	10	1,300
DF405	5	1,860	4,465	10	1,300
DF408	8	2,600	6,240	10	1,700
DF 410**	10	3,470	7,630	10	2,000
DF 412**	12	4,170	9,180	10	2,000

* with ambient air at +30 °C and relative humidity of 70%

** only for DF duct

- Operating range: 10 °C to 40°C (ambient temperature in the swimming pool hall)
- Optimum operating conditions: between 25°C and 30°C

2. Installation

2.1 Installation requirements

- The unit must be installed in premises that are closed and well aired; in an area that is: not exposed to freezing risk, out of reach of water splashes, and where no pool maintenance products are stored, the installation in outside involves the suppression of the guarantee,
- Install the appliance on a level base, to avoid any overflows from the condensation tray,
- Provide easy access to the unit for maintenance and connections. Leave 1 metre on one side of the filter. If this is not the case, the cost of handling the unit will not be covered.
- Place nothing in front of or on the blowing and suction grates,
- Anti-vibration studs (supplied) must be installed under the base when the appliance is placed on the floor or on a support,
- For a swimming pool building with a high ceiling or visible roof frame: destratification of the upper layers of the room = one or several fans with PVC blades or an air extractor with fresh air intake. **Warning! 230V AC appliances = must be outside volume 1 (see under),**
- Risk of stratification:
 - height of the room < 4 to 5 meters: mechanical ventilator unit or extractor,
 - height of the room > 5 to 8 meters: ceiling fans with large blades.
- Obligation of the building: pool hall = high hygrometry. When building, check that:
 - the materials used are compatible with a swimming pool environment,
 - the walls are sufficiently waterproofed and insulated to avoid condensation forming in the room when relative humidity reaches 60 to 70%,Buildings with lightweight structures (verandas, shelters, etc.) : there is no risk of deterioration of the structure, even in case of dew as they are designed to support this (even with a relative humidity of 70%),
- Ventilation, renewal of air:
 - private pools: highly recommended,
 - public pools: compulsory.The air can be renewed by:
 - a simple mechanical ventilation unit,
 - a wall or roof extractor with fresh air intakes,This ventilation ensures the hygienic renewal of air, the removal of any chloramines present in the air, and the elimination of excessively hot air, whilst contributing to the dehumidification of the room.
- Meet the the applicable standard in the country of installation. Following French norm NFC 15-100, the appliance should be installed:
 - Outside of area 1 (more than 2 metres from the edge of the pool) provided it is out of reach of potential splashes and protected by a dedicated 30 mA fuse,
 - Outside of area 2 (more than 3.5 metres from the edge of the pool) if the above conditions are not satisfied.



EN

2.2 Connection of the condensation drainage

An evacuation of condensation is available for the appliance in Ø15/21 female.

A 1" PVC union and a Ø32 half-union are provided for gluing, which you connect to a pipe fitted with a U-tube system with draining plug.

For placing the condensation drainage: see mark "A Ø15/21" § "dimensions" in the appendix.

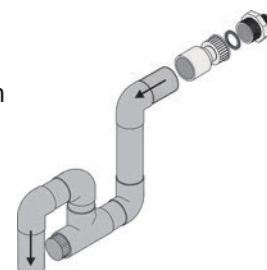

To the sewer

2.3 Connection to a duct network for DF ducted

- Install the appliance in a technical room that is protected from freezing.
- Connect the intake and blower duct (or standard parts) respecting the air circulation direction: the intake and blowing of hot and dry air each side of the appliance are from 635x410 mm frames (650x540 mm frames for DF 410-412).
- Optional sheet metal parts can be connected to the intake and the blowing:
 - 90° horizontal elbow (option)
 - 90° vertical elbow (option)
 - circular exit \varnothing 315 or 400 for DF 410-412 (option)
 - sound trap (option)

 • Plan a water drainage point at the low point for possible projection of water in the ducts.

• To ensure the correct operation of the system, the duct network must be sized according to the air flow delivered by the appliance (see table below). For very long or complicated networks please contact us.

• The blower grates must be fitted with registers for better air distribution.

Minimum cross section for blower and intake ducts

Appliance	Unit	DF 403	DF 405	DF 408	DF 410	DF 412
Rectangular duct	mm	400 x 200	400 x 200	400 x 200	400 x 300	400 x 300
Circular duct	mm	315	315	315	400	400

 Cross section: for a maximum length of 20 meters, air speed: 5 to 6 meters/second
Average load losses by air flow direction change, 90° elbow or by T = 1 mm EC

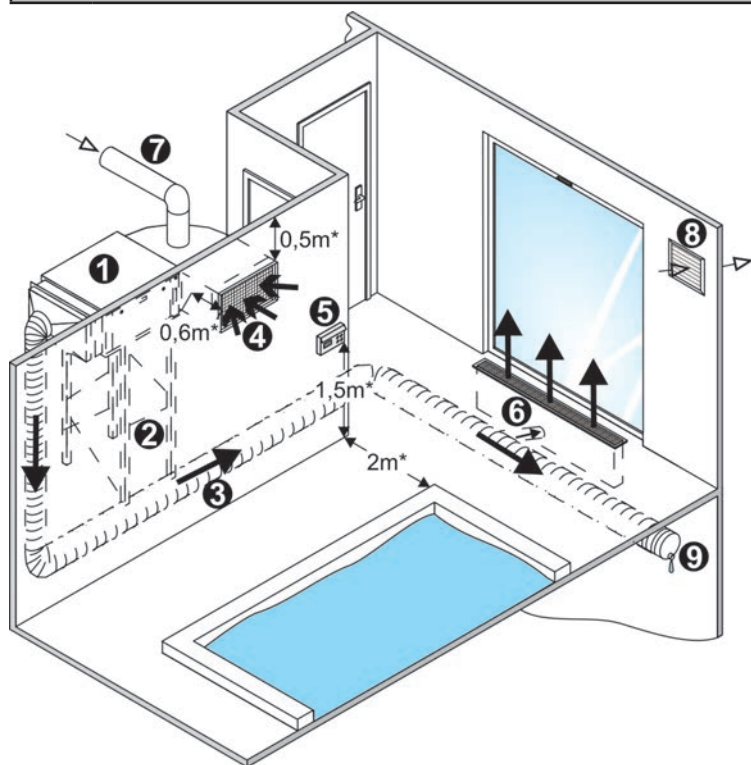

*minimum distance

- 1: DF 403-405-408-410-412 duct
- 2: support seat
- 3: duct
- 4: suction
- 5: Hygro Control
- 6: blower
- 7: fresh air intake
- 8: air renewal system (see §"2.1 Installation requirements")
- 9: duct exhaust

2.4 Inset connection for DF inset

Install the appliance in a technical room that is protected from freezing.

For the installation of parts that must be embedded/sealed please refer to the supplied procedure.



Make sure the appliance is well sealed to the wall by the seal.

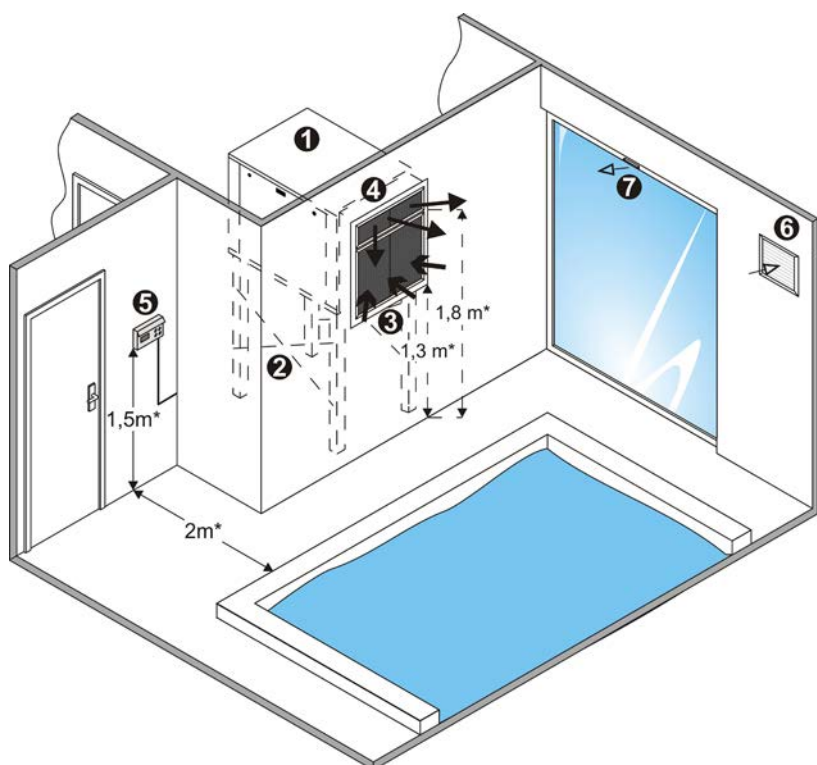

*minimum distance

1: DF 403-405-408 inset

2: support seat

3: suction grid

4: blowing grids

5: Hygro Control

6: air renewal system (see §"2.1 Installation requirements")

7: fresh air intake

EN

Fixing the appliance to the wall is recommended. You have squares (see part §"1.2 Contents").

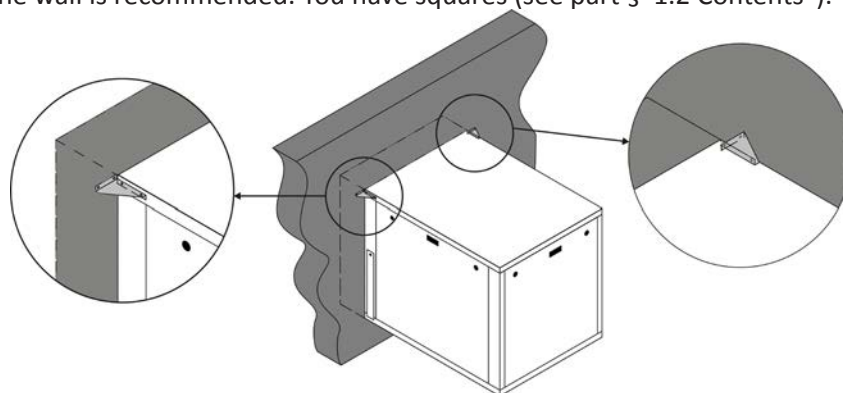

2.5 Electric connections

2.5.1 Voltage and protection

- The electrical supply must be provided through a protection and circuit breaking device (not supplied) complying with the standards and regulations in force in the country where it is installed,
- Electrical protection: 30 mA ground fault circuit breaker.

- **The electrical connection lines must be fixed,**
- **Acceptable variation in voltage: $\pm 10\%$ (during operation).**

2.5.2 Connections

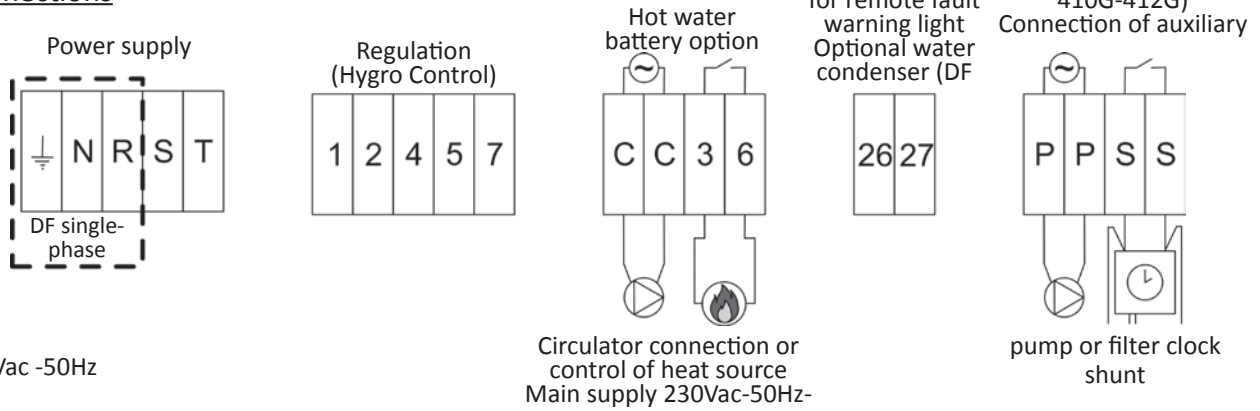

230Vac -50Hz

contact (230Vac -50Hz - 5A maximum)

- **Incorrectly tightened terminals may cause the terminal unit to heat up and invalidate the warranty.**
- **The equipment must be connected to an earth socket.**
- **Risk of electrical shock inside the device. Only a qualified and experienced technician is authorised to carry out cabling in the equipment. If the supply cable is damaged, it must be replaced by a qualified technician.**

2.5.3 Cable sizes

- Supply cable size: for cables of a maximum length of 20 metres (calculation basis: 5A/mm²), this must be checked and adapted depending on installation conditions.

Unit	Option	Voltage	Nominal power consumption	Maximum power consumption	Cable cross-section	
					mm ²	
DF 403 Single-phase	Without option or hot water battery	230V-50Hz-	7.9	13.2	3 x 2.5	3G2.5
	Extra heating 4.5 kW	230V-50Hz-	27.4	35	3 x 10	3G10
DF 405 Single-phase	Without option or hot water battery	230V-50Hz-	10.1	16.1	3 x 4	3G4
	Extra heating 4.5 kW	230V-50Hz-	29.6	38	3 x 10	3G10
DF 405 three-phase	Without option or hot water battery	400V-50Hz-	4.9	7.3	5 x 2.5	5G2.5
	Extra heating 4.5 kW	400V-50Hz-	11.4	14.6	5 x 2.5	5G2.5
DF 408 Single-phase	Without option or hot water battery	230V-50Hz-	15.6	24.8	3 x 6	3G6
	Extra heating 4.5 kW	230V-50Hz-	35.1	46.6	3 x 16	3G16
DF 408 three-phase	Without option or hot water battery	400V-50Hz-	7.2	9.5	5 x 2.5	5G2.5
	Extra heating 9 kW	400V-50Hz-	20.2	24	5 x 6	5G6
DF 410 mono-phase	Without option or hot water battery	230V-50Hz-	16.2	25.7	3 x 6	3G6
	Extra heating 4.5 kW	230V-50Hz-	35.7	47.5	3 x 16	3G16
DF 410 three-phase	Without option or hot water battery	400V-50Hz-	7.6	11.9	5 x 2.5	5G2.5
	Extra heating 9 kW	400V-50Hz-	20.6	26.5	5 x 6	5G6
DF 412 mono-phase	Without option or hot water battery	230V-50Hz-	18.9	32.7	3 x 10	3G10
	Extra heating 4.5 kW	230V-50Hz-	38.4	54.5	3 x 16	3G16
DF 412 three-phase	Without option or hot water battery	400V-50Hz-	9.2	14	5 x 2.5	5G2.5
	Extra heating 9 kW	400V-50Hz-	22.2	28.5	5 x 6	5G6

2.5.4 Hygro Control connection

i Hygro Control = digital display hygro-thermostat = display and setting of pool hall temperature* and humidity

- For installation location: see § “2.3 Connection to a duct network for DF ducted” or § “2.4 Inset connection for DF inset” and refer to § “2.1 Installation requirements”,
- The Hygro-Control must be correctly influenced by the swimming pool room air,
- Connect to terminals 4-5 on the electric box.

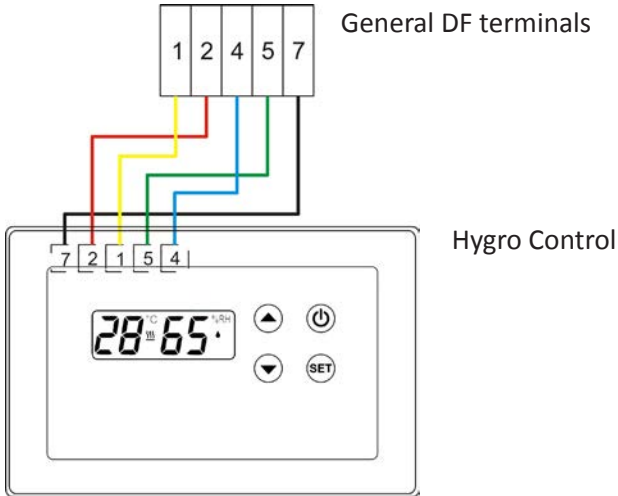

	“on/off”
SET	Temperature* and humidity programming or hygro-thermostat settings
	Setting the values

- !**
- The numbering of the terminals must be respected,
 - Do not route the cable with other 230V or 400V cables to avoid any risk of signal interference.
 - The device must be installed indoors, away from frost.
 - Block the place where the cable comes out of the wall or seal it with other materials except silicone and materials containing silicone, to prevent fresh air entering through the sheath or through the partition,
 - Do not install the device near a heat source (radiator, chimney, air vent, etc.) or in swimming pool premises with air that is saturated with chlorine.

Technical characteristics of the Hygro-Control

Dimensions: width/height/depth	145 x 105 x 45 mm	
Maximum connection distance	30 metres	
Cable cross-section	5x1.5mm ²	
Voltage	12 Vac	
Admissible room temperature	0 °C to 55 °C	
Admissible rate of humidity	0 % to 90 %	
Hysteresis	Humidity	4%
	Temperature	1°C
Protection index	IP30	

Display

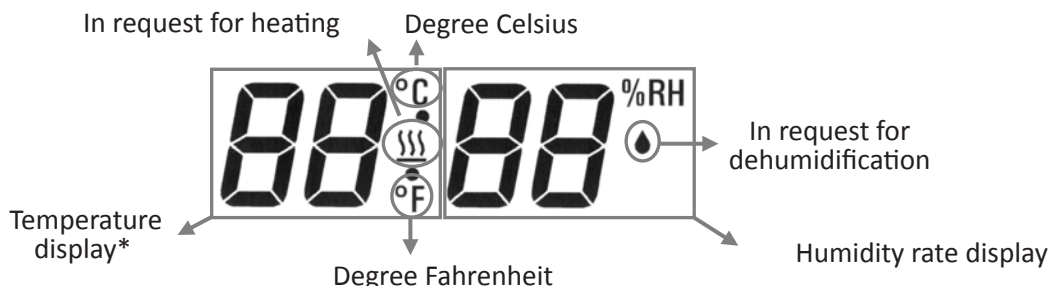

*only if your appliance is fitted with the hot water battery option, or electrical make-up.

Hygro Control display	Hygro-thermostat	Hygrostat	Thermostat
On standby	-- --	--	--
Active	28 °C 65 %RH	65 %RH	28 °C

By default: display of the temperature and/or desired humidity rate (= setpoints).



Display of the ambient temperature and/or humidity rate measured by pressing **SET** once, °C and/or %RH flash. To exit, press **SET**, or wait 10 seconds.

Starting up and stopping the appliance





Press  for 5 seconds.

Locking/unlocking the keyboard

To lock and unlock the keyboard:

- Hygro Control must be **active**,
- Press  and  simultaneously for 3 seconds,
- The **LOC** message is displayed or is removed.

Adjusting the setpoints

- Hygro Control must be **active**,
- Press  for 3 seconds, the modifiable value blinks,
- Use  or  to set the value,
- Press  to confirm,
- and then  to exit.



Adjustment range	Minimum	Maximum
Humidity	55%	70%
Temperature	5 °C	32 °C

Comfort setting
65%
28 °C

After 30 seconds inactivity on the keyboard the screen returns automatically to the basic screen and the most recent setting (if not confirmed by pressing ) will not be taken into account.

Test mode / Manual override

To make the machine operate for 30 minutes, even though the climatic conditions do not demand it:





- Hygro Control must be active,
- Press on  for 3 seconds, a value blinks,
- Press  again for 10 seconds,
- All the digits light **88.88**, **88** or **88** and the appliance starts up.

To quit this mode, press the key  for 5 seconds.

Parameter setting in hygro-thermostat or hygostat mode

Hygro Control shipped with the setting for hygro-thermostat mode for appliances with the heating option for hygostat mode for devices without the heating option.

This setting must be changed if a heating option is added or removed.

- Hygro Control must be in standby,
- Press  and  for 3 seconds: (hygro-thermostat mode),
- Press  or  to select the function: (hygostat mode), (thermostat mode)
- Validate by pressing .

2.6 Connecting the options

2.6.1 Hot water battery

DF sheath

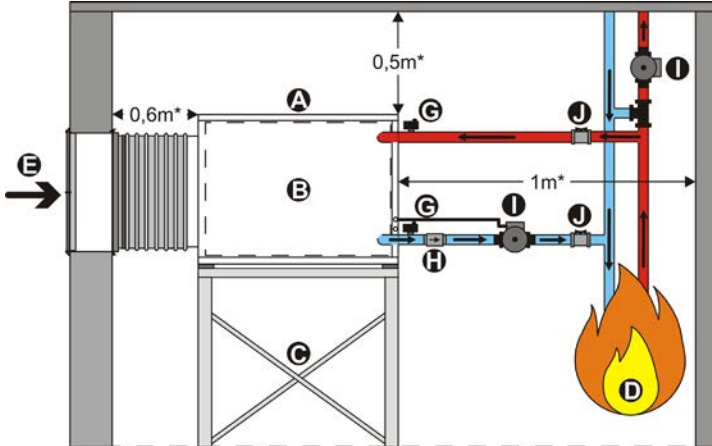

* minimum distance

A: DF
B: hot water battery
C: support seat
D: heating source
E: suction

DF Inset

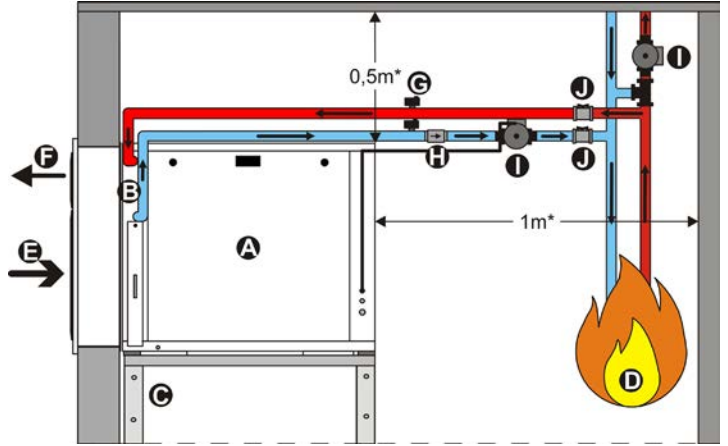

F: blower
G: automatic purge
H: check valve or solenoid valve
I: circulator
J: shut-off valve

Unit	Power		Water flow		Water load loss		Air load loss	
	kW		m ³ /h		mCE		Pa	
Primary	90/70 °C	50/40 °C	90/70 °C	50/40 °C	90/70 °C	50/40 °C	90/70 °C	50/40 °C
DF 403-405 G	14.6	4.6	0.65	0.4	0.055	0.025	16.6	16.6
DF 408 G	17.6	5.5	0.78	0.48	0.078	0.035	25.2	25.2
DF 410-412 G	23	7	1.1	0.9	0.204	0.157	23	23
DF 403-405 E	12.4	3.9	0.56	0.34	0.059	0.026	34.3	34.3
DF 408 E	14.8	4.6	0.66	0.4	0.081	0.035	52.9	52.9

EN



Power returned to the air at 27°C, entering the hot water battery.



- Connection to the primary circuit: front any valve or pump.
- Water temperature input to the hot water battery: 50 °C minimum, 90 °C maximum.
- Maximum pressure water battery circuit: 3 bar.

2.6.2 Titanium water condenser (only on DF410G-DF412G)

- Average flow rate of water in the condenser: 7m³/h
- Condenser inlet and outlet: PVC Ø50

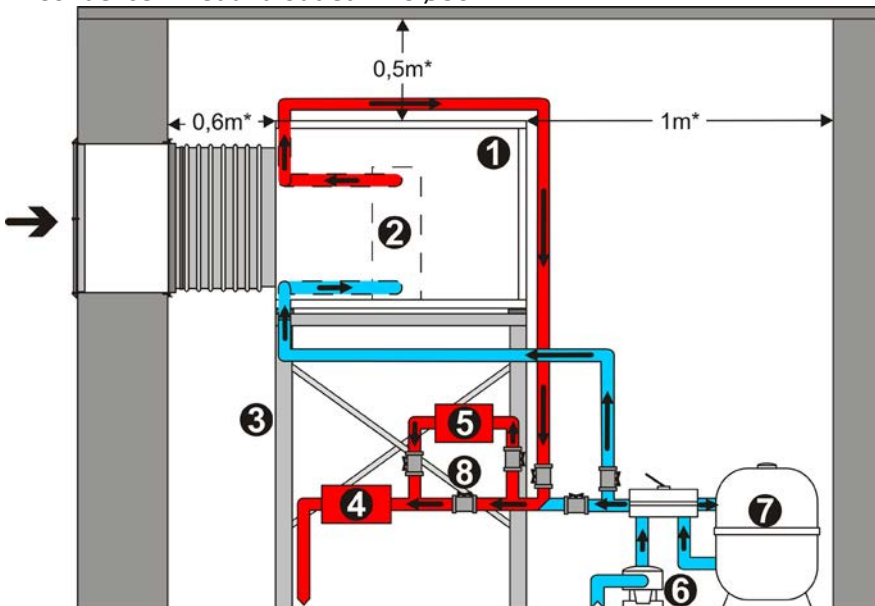

- * minimum distance
- 1: DF 410-412 duct
- 2: water condenser
- 3: support seat
- 4: water treatment
- 5: main water heating system
- 6: pump
- 7: filter
- 8: by-pass

3. Use

3.1 Start the appliance

- Power on the appliance (by switching on the general terminal board),
- **Only for three-phased DF:** when the dehumidifier is switched on, check the status of the phase controller (KA4):
 - None of the indicators are lit = no power supply,
 - Green and orange indicators are lit = normal operating conditions,,
 - Only green indicator lit = power supply is OK but phase inversion issue or missing phase. Cut off the power supply and invert two phases directly on the appliance connection terminal board. If the orange indicator does not light up after the phase inversion, check for the presence of the three phases on the phase order controller KA4.



This operation must be only be carried out by a qualified professional.
The phase order controller protects the compressor. It's forbidden to invert phases:

- on the power contactor (KM1)
- on the compressor

- Set the humidity and temperature on the Hygro Control so that it triggers dehumidifying and / or air heating (optional), see §"2.5.4 Hygro Control connection".



When the "ECP 600" regulator is switched on ventilation is active for 5 minutes. This also occurs if the appliance is powered on and the "on/off" switch of the Hygro Control delivered with the appliance is used.

3.2 Checks

In the Hygro Control comfort model (see §"2.5.4 Hygro Control connection")

- check that hot air is coming out of the blower grates,
- check that the appliance is draining condensation.

3.3 Adjusting the duct network (only on ducted DF)

Set the air flow by adjusting the grate dampers (recommended speed ≈ metre/second) identically on all the blower grates.

3.4 Options starting up

The heating options are operational from 4°C surrounding air temperature.

3.4.1 Extra heating

- Starting up: adjust the thermostat to between 26 and 28 °C (maximum 30 °C), in general choose an air temperature 1 to 2 °C higher than the pool water temperature,



If your pool has a cover (shutter or bubble sheet type, etc.), you can lower the room temperature when it is in place (by adjusting the thermostat to about 20 °C) and raise the pool hall temperature before removing the cover.

- Check that with the "VI/VP" switch on "VI", and no dehumidification or defrosting cycles in progress:
 - the fan stops operating, after post-ventilation of 3 minutes when the reference room temperature on the pool room thermostat is lowered,
 - in the event of abnormal overheating, the appliance shuts down the heating option automatically, by shutting off the heating elements and keeping the ventilation operational (for as long as a heating request is active).

This safety device has two levels of triggering:

- 1) by "THS" safety thermostat if the T°C is > 65 °C (it is automatically reset),
- 2) if the temperature continues to increase, the second positive "THSM" safety thermostat (see place § "dimensions" in the appendix) puts the appliance into safety mode.
=> reset it manually (with power off), after having checked that the appliance airflow is correct (with the "VI/VP" switch on "VP"), that the grates are not obstructed, that the filter is not clogged, and the fan is not defective.

3.4.2 Hot water battery

- Supply the battery with hot water at 50 °C minimum from the heat source (boiler, heat pump, geothermal energy, solar heating), installation must be carried out by a qualified technician, using a circulator (not supplied) which will be powered by terminals C-C on the electrical terminal board.



Insulate the hot water battery hot water pipes between the heat source and the appliance (for the purpose of limiting calorie loss).

- Connection to a ZPCE double circuit gas boiler: connect the terminals 3-6 of the terminal board, to terminals 3-6 of the boiler terminal board,



Terminals 3-6 can also ensure a heat source control function (see §"2.5.2 Connections").

- Starting up: adjust the thermostat to between 26 and 28 °C (maximum 30 °C), in general choose an air temperature 1 to 2 °C higher than the pool water temperature,



if your pool has a cover (shutter or bubble sheet type, etc.), you can lower the room temperature when it is in place (by adjusting the thermostat to about 20 °C) and raise the pool hall temperature before removing the cover.

- A post-ventilation runs for 3 minutes when the reference temperature is reduced on the thermostat located in the pool hall (with the “VI/VP” switch on “VI”, without any dehumidification or defrosting cycles in progress): check that the circulator stops.

Warning - low temperature: if the dehumidifier hot water battery is not supplied by a boiler, but by an athermal or a geothermal system, the heating circuit water will be at a maximum temperature of 50-40 °C. The power of the battery will then be considerably lower (3 to 4 times less) than the nominal power given for water at 90-70 °C. If the power of the battery is lower than the heating needs of the room, plan for additional heating by radiator, heated floor or fan convactor.

3.4.3 Titanium water condenser (only on DF410G-DF412G)

- Connect the intake and output to the filter using a by-pass, according to the markings on the appliance (before the pool water treatment system), see §2.6.2 Titanium water condenser (only on DF410G-DF412G)”,
- Settings of the by-pass for the water condenser (4): half open the valve (1), the fully open the valves (2) and (3).
- Plan to shunt the filter clock from the S-S terminals on the DF electrical terminal board,
- In the case of a hydraulic connection with pump that is independent of the filtering system, plan to power this pump using the P-P terminals on the DF terminal board (maximum power: 60W with 230V AC, otherwise relay the power supply from an extra electric contactor),
- Starting up: set the “TH” digital display thermostat fitted inside the electrical box:
 - Press **SET** to display the current reference value (factory preset at 27 °C, thus the thermostat output will be activated when the pool room temperature will rises above 29 °C and deactivated if the temperature drops below 27 °C): the “out 1” LED blinks (hysteresis = 2 °C),
 - press ▲ or ▼ (possible range values: 25 °C minimum and 45 °C maximum),
 - press **SET**, or do not operate for 15 seconds, to confirm.
- Check that the filter pump starts when the adjustment of this digital display thermostat is reduced to below the surrounding temperature.

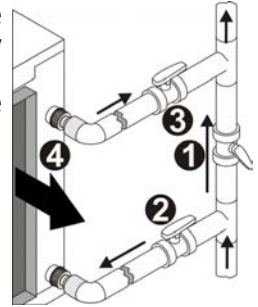

EN

4. Maintenance

4.1 Maintenance instructions

A general servicing of the appliance is recommended both when winterizing and when restarting in order to ensure the proper operation of your heat pump, to preserve its performance and to prevent potential failures. These operations are carried out at the user's expense, by a qualified technician. Appliance powered off and unplugged from power supply! The appliance must have filters fitted when operating.

4.1.1 Monthly checks

- Check visually that the condensation is drained.
- Check for clogging in the filter:



- wash the filter with warm soapy water,
- rinse it abundantly and dry it,
- replace them if necessary.



4.1.2 Annual checks

- Check that the electric cable connections, contactors are correctly tightened,
- Check that each command relay, power switch and electronic protection device is operational,

i On the three-phase DF, via the phase controller (KA4), any modification of the order of phases on the distribution network or on the existing electrical installation is detected. The appliance then goes into fault mode (Led A1 and A3 ON, and orange light OFF for KA4), refer to §3.1 Start the appliance”.

- Check the adjustment and operation of the Hygro Control and the water condenser thermostat if necessary clean the dust inside it using a jet of air,
- Clean the whole unit with a slightly damp cloth,
- Check the cleanliness of the condensation drainage tray and tube,
- Check the condition of the insulating foam on the technical compartment.

4.2 Spare parts

Spare parts	Hygro Control sensor	Filter			Support seat	
Item Code	WCE03431	DF 403-405-408		DF 410-412	WTC040000	
		760x460x20mm	2* x (380x460x22mm)			855x585mm
		WTL00760	WTL00763			WTL00766
Representation						

*useful when there is not enough room to take out a standard size filter

4.3 Recycling

 This symbol means that your appliance must not be thrown into a normal bin. It will be selectively collected for the purpose of reuse, recycling or creating value. Any substances it may contain which are potentially dangerous to the environment shall be eliminated or neutralised.

Enquire with your retailer for the conditions that apply to the recycling of your product.

5. Troubleshooting

5.1 Status and faults in the ECP600 settings

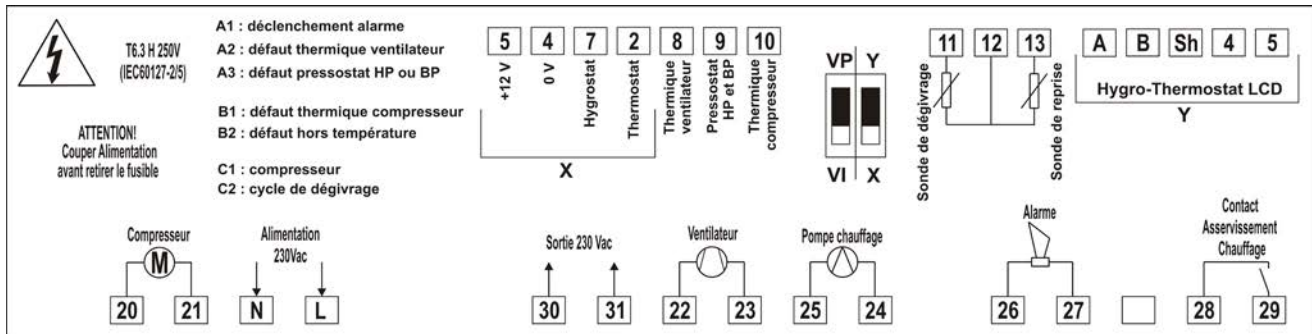

Terminals	Description
N - L	mains-supply 230Vac-50Hz to the ECP600 regulator
20 - 21	output from compressor supply 230 Vac -50Hz
30 - 31	230Vac-50Hz output (used with the water condenser option) and protected by the ECP600 fuse
22 - 23	ventilator 230Vac-50Hz output
25 - 24	output for circulator hot water battery option 230Vac-50Hz
26 - 27	output alarm report 230Vac-50Hz
28 - 29	output contact "NO" (without polarity) control of heat source hot water battery option
11 - 12 - 13	input control sensor type PTC (inlet or defrost)
4 - 5	power supply 12Vac-50Hz
7	input 6Vac-50Hz given by the hygrostat function (request active if 6Vac-50Hz between 7 and 4)
2	input 6Vac-50Hz given by the thermostat function (request active if 6Vac-50Hz between 2 and 4)
8	input 12Vac-50Hz fan heat fault (shunted not active) (fault active if 0Vac-50Hz between 8 and 4, LEDs A1 and A2 are ON)
9	input 12Vac-50Hz faults BP and/or HP, and/or phase order (DF three-phase) (fault active if 0Vac-50Hz between 9 and 4, LEDs A1 and A3 are ON)
10	input 12Vac-50Hz compressor heat fault (shunted not active) (fault active if 0Vac-50Hz between 10 and 4, LEDs A1 and B1 are ON)
Hygro-Thermostat LCD A-B-Sh-4-5	Not used
Switch VI/VP	"intermittent ventilation" (standard setting) or "permanent ventilation" (to permanently circulate the pool hall air) The ventilation is active when: - dehumidification is triggered, - a defrosting cycle is started, - pool hall air heating is triggered, - active for at least 5 minutes in one hour without any of these triggers. On VP, the compressor starts after a delay of 1 minute.

LEDs	Description
A2 fan heat fault	DF : Not used
A3 high or low pressure switch fault	Triggering HP and/or LP switch and/or phase order relay KA4 (only on DF three-phase) <ul style="list-style-type: none"> • HP: check that the ventilator is operational, that the air filter is clean and the belt is tight enough, • LP: insufficient gas, call a specialist, • KA4: check for the presence of the 3 phases, if so, see §"3.1 Start the appliance".
B1 compressor heat fault	DF: Not used
B2 temperature range fault	<ul style="list-style-type: none"> • Restart sensor is out of order • If the sensor returns to within its operating range: • there is a 10 seconds delay before the fault is cleared, • there is a minute delay before restarting the compressor (if a dehumidification request is still active)
C1 Compressor	Fix = compressing under operation Blinking = time delay in process
C2 defrosting cycle	<ul style="list-style-type: none"> • Cooling circuit temperature < than -5 °C or > than 40 °C, • A defrosting cycle is in progress (temperature is >-5 °C). The compressor is stopped and ventilation is maintained, • The defrosting sensor is out of order. • The defrosting cycle stops when the temperature of the sensor goes over 3.2 °C. • In all cases, if the ventilator is active before the triggering of this fault, ventilation is maintained. • If the sensor returns to within its operating range: • there is a 10 seconds delay before the fault is cleared, • There is a minute delay before restarting the compressor (if a dehumidification request is still active)

EN



5.2 FAQ

Why is my appliance draining water?	Your appliance gives off water, called condensation. This water is the humidity your dehumidifier condenses to dry the air.
Why are my French windows covered with water whilst my appliance is dehumidifying?	This is the dew point, which means the moment when the water vapour contained in the air will change states when in contact with a cold surface. This is the phenomenon of condensation.

6. Registering the product

Register your product on our website:

- you will be the first to be informed of new Zodiac® products and special offers,
- You can help us to constantly improve our product quality.

Europe & Rest of the World	www.zodiac-poolcare.com	
America	www.zodiacpoolsystems.com	
Australia – Pacific	www.zodiac.com.au	

Electric diagram

DF single-phase

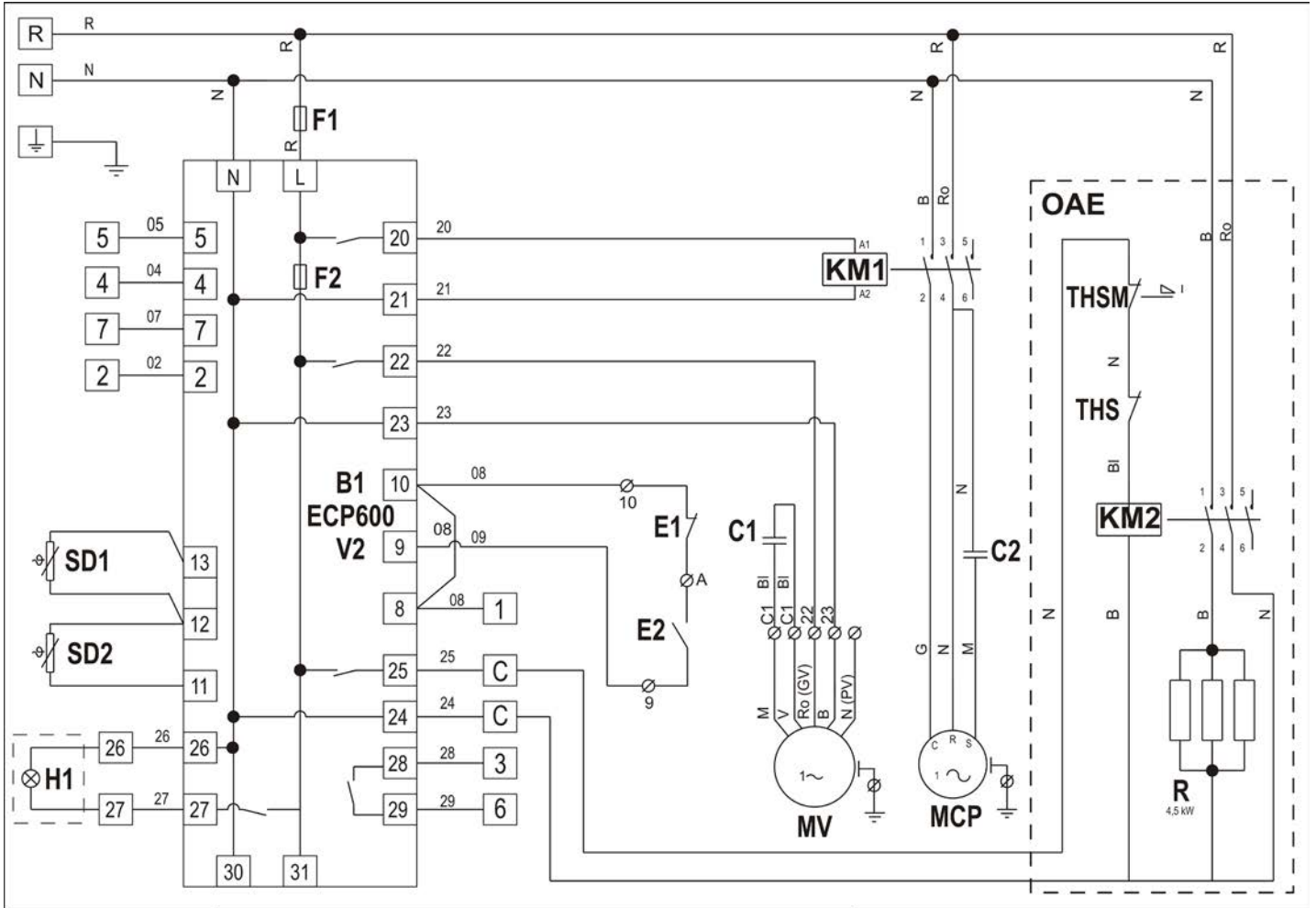

DF three-phase

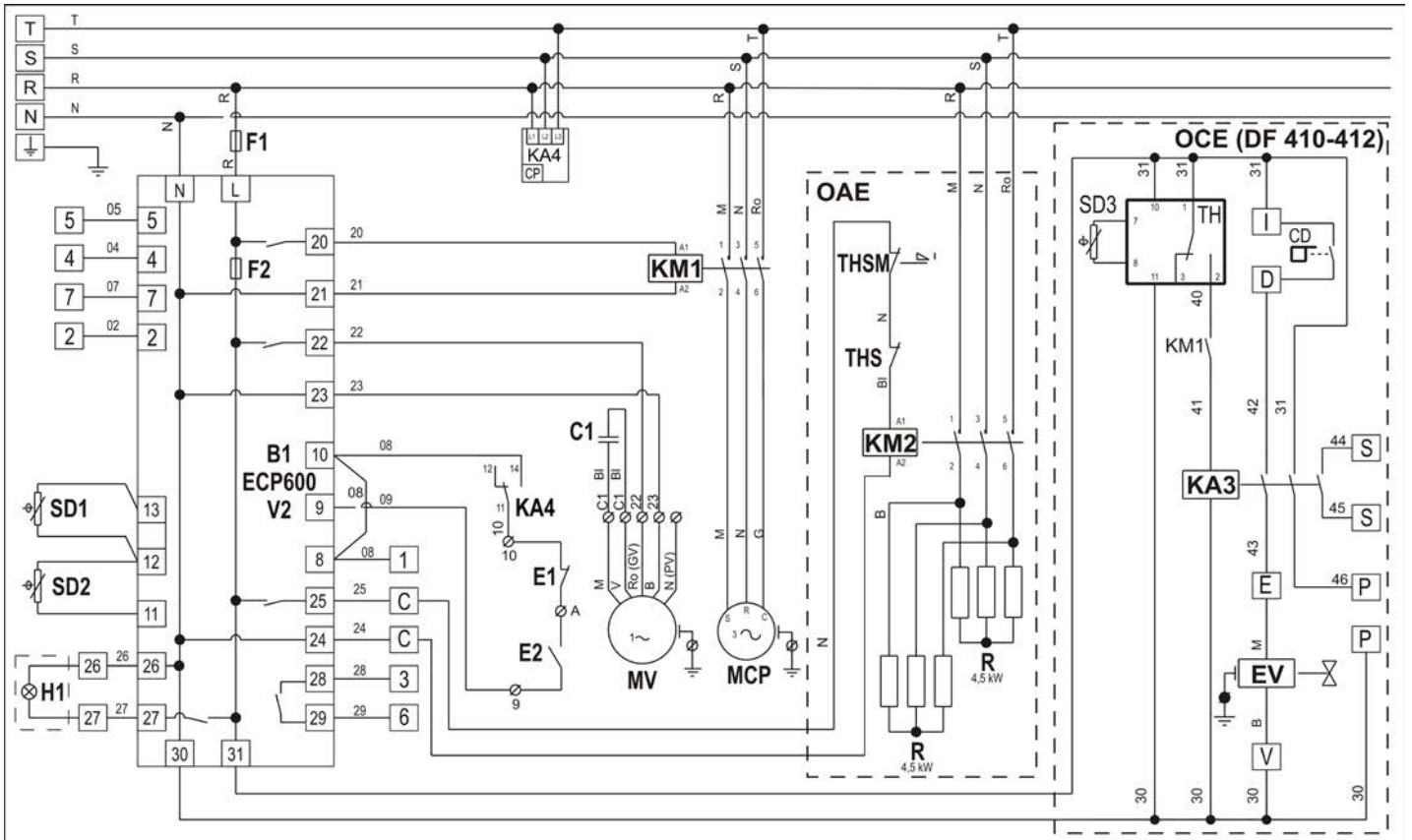

N-R	Single phase main supply 230Vac-1N-50Hz
N-R-S-T	Three phase main supply 400Vac-3N-50Hz
	Ground
∅	Connection terminal
3-6	Control of heating for boiler or an existing heating system
5-7-2-4-1	Connection of Hygro Control (see §2.5.4)
26-27	Supply (230 Vac-50Hz) for remote fault warning light or relaying
C-C	Supply (230Vac-50Hz) for battery circulator or used for electric logic of the heating option by electric backing
P-P	Supply for controlling the filtering pump (OCE)
S-S	Control for filtering clock (OCE)
B1	Command logic controller ECP 600
C1	Ventilator capacitor (DF 403-405 = 4µf, DF 408 = 10µf, DF410-412 = 16µf)
C2	Compressor capacitor (DF 403 = 40µf, DF405 = 45µf, DF 408= 55µf, DF 410 = 60µf, DF 412 = 50µf)
CD	Flow rate controller (OCE)
E1	High pressure switch
E2	Low pressure switch
EV	Solendoid valve (OCE)
F1	General main fuse 6.3A
F2	Fuse T=6,3A – 5 x 20
H1	Alarm lamp (outside, 230V-50Hz, not provided)
KA3	Command relay water condenser option
KA4	Phase order relay (CP)
KM1	Compressor power contactor
KM2	Back up heating power contactor (OAE)
MCP	Compressor motor (230Vac/50Hz or 400Vac/50Hz)
MV	Ventilator motor IE3 (230Vac/50Hz)
GV	High speed
PV	Low speed
OAE	Back up heating option
OCE	Titanium water condenser (only on DF 410-412)
R	Heating resistor 4.5kW (OAE)
TH	Thermostat of regulation to digital display (OCE)
THS	High limit thermostat (automatic reset) (OAE)
THSM	Positive high limit thermostat (manual reset) (OAE)
SD1	Air inlet sensor (black sheath)
SD2	Defrost sensor (grey sheath)
SD3	Regulation sensor for water condenser option (white sheath)
B	Blue
Bl	White
G	Grey
M	Brown
N	Black
R	Red
Ro	Pink
V	Green

Dimensions

Weight without option (Kg)

DF 403 G	DF 405 G	DF 408 G	DF 410G	DF 412G
113	114	117	147	149
DF 403 E	DF 405 E	DF 408 E	Parts for sealing	Grids
129	130	133	22	7

DF 403-405-408 G

Face

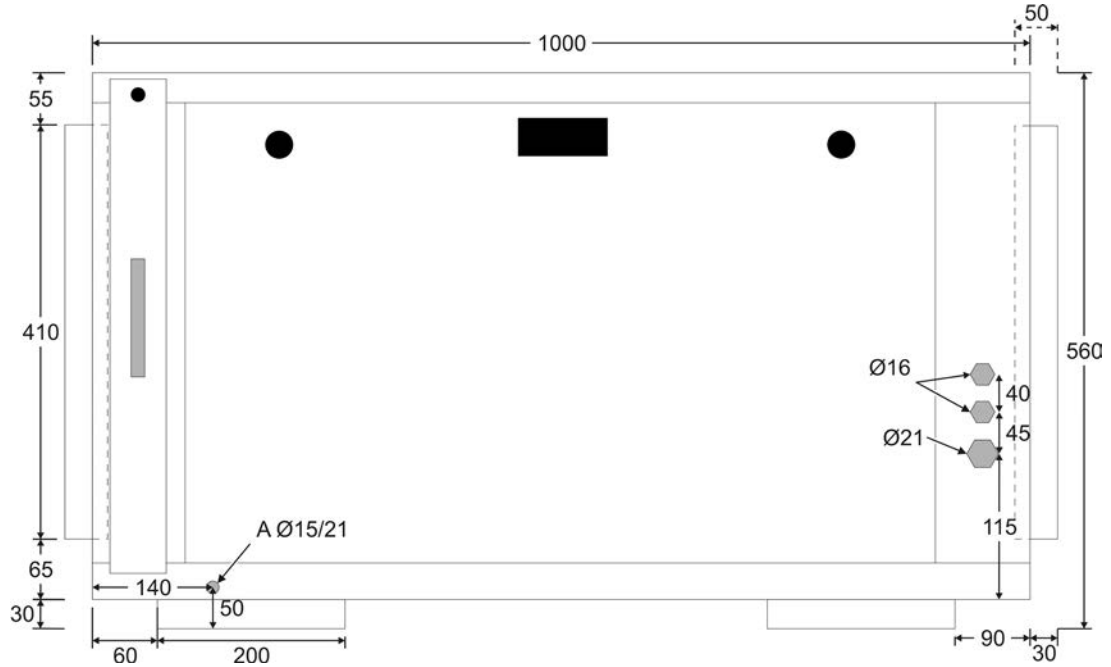

Suction side

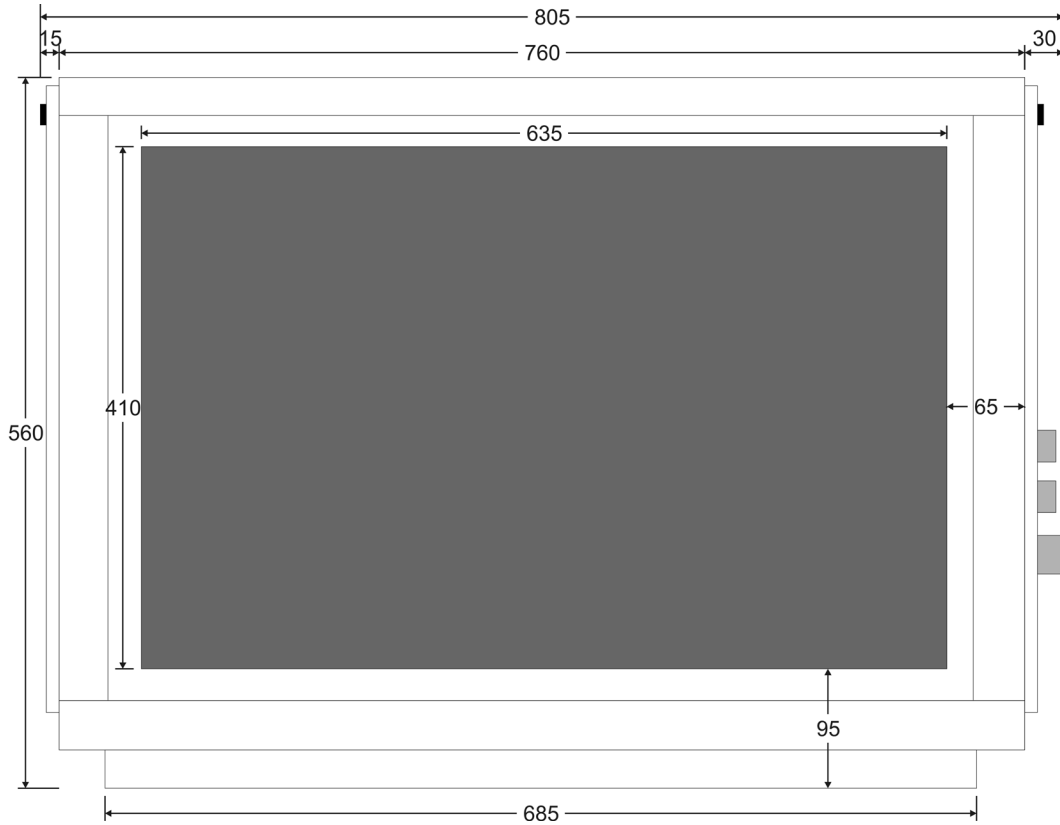

DF 410-412 G

Face



Blowing side

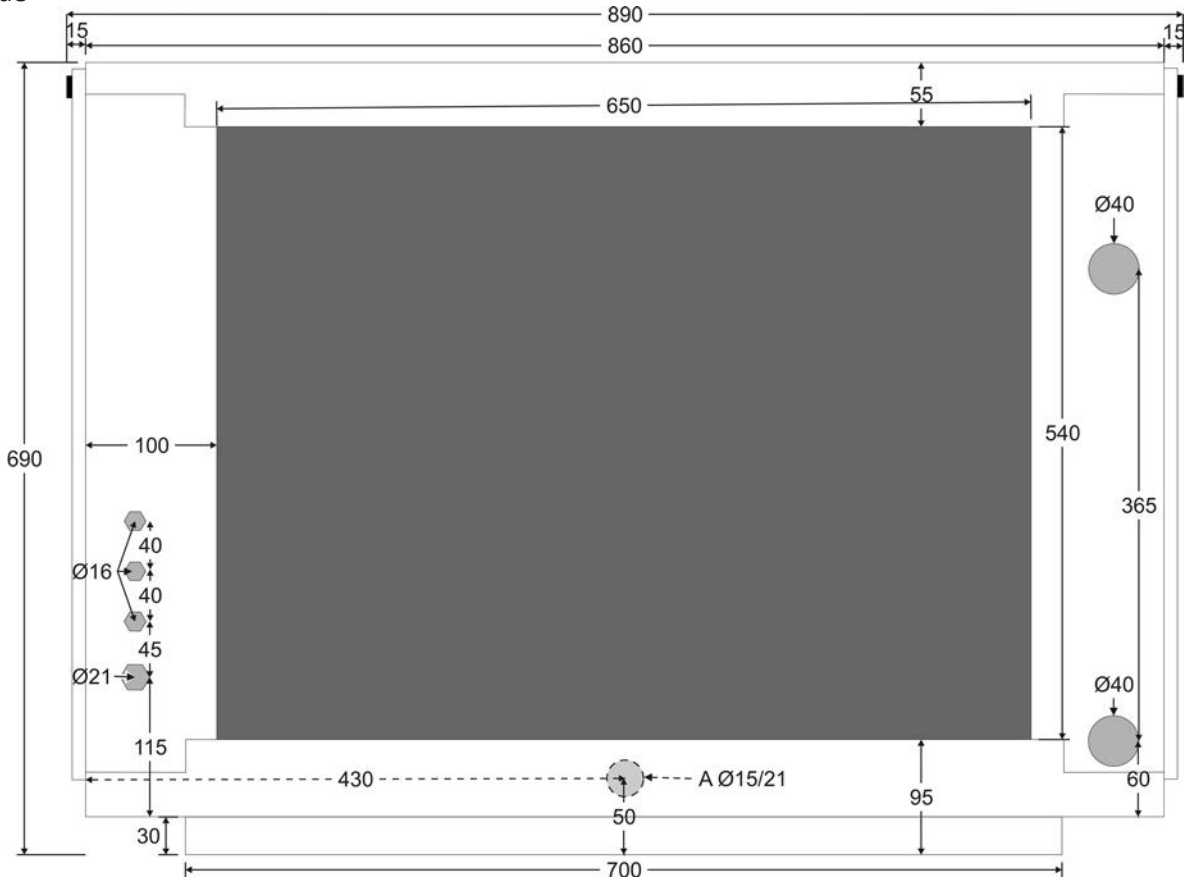

Options

Hot water battery

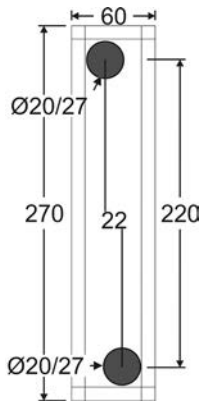

Side

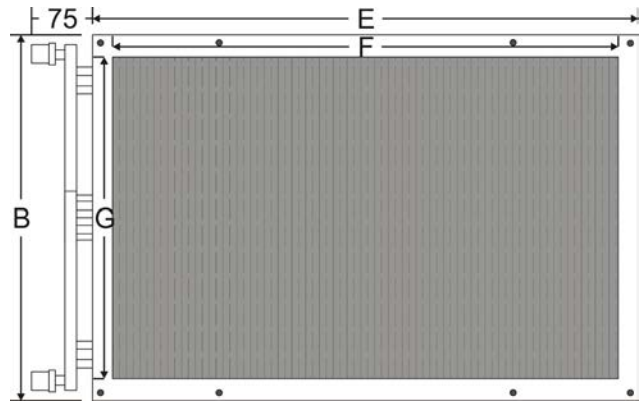

Face

	A	B	C	D	E	F	G
DF 403-405-408 G	90	425	22	385	680	630	400
DF 410-412 G	125	580	44	510	695	645	530

Back up heating

DF 403-405-408 G

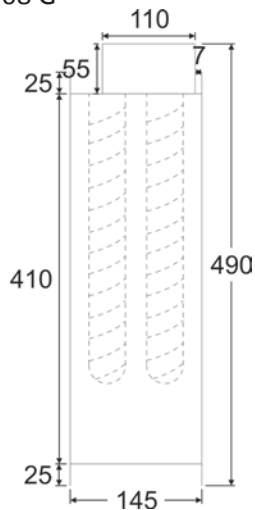

Side

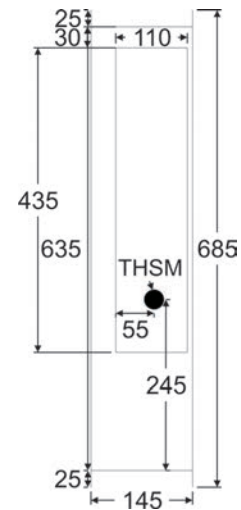

Upper

DF 410-412 G

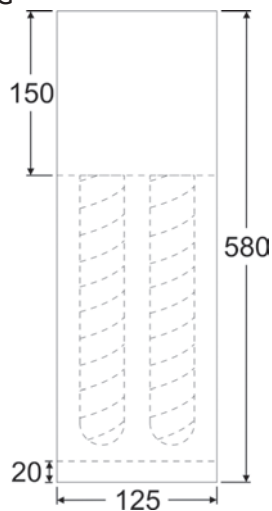

Side

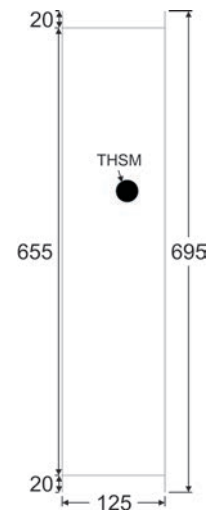

Upper

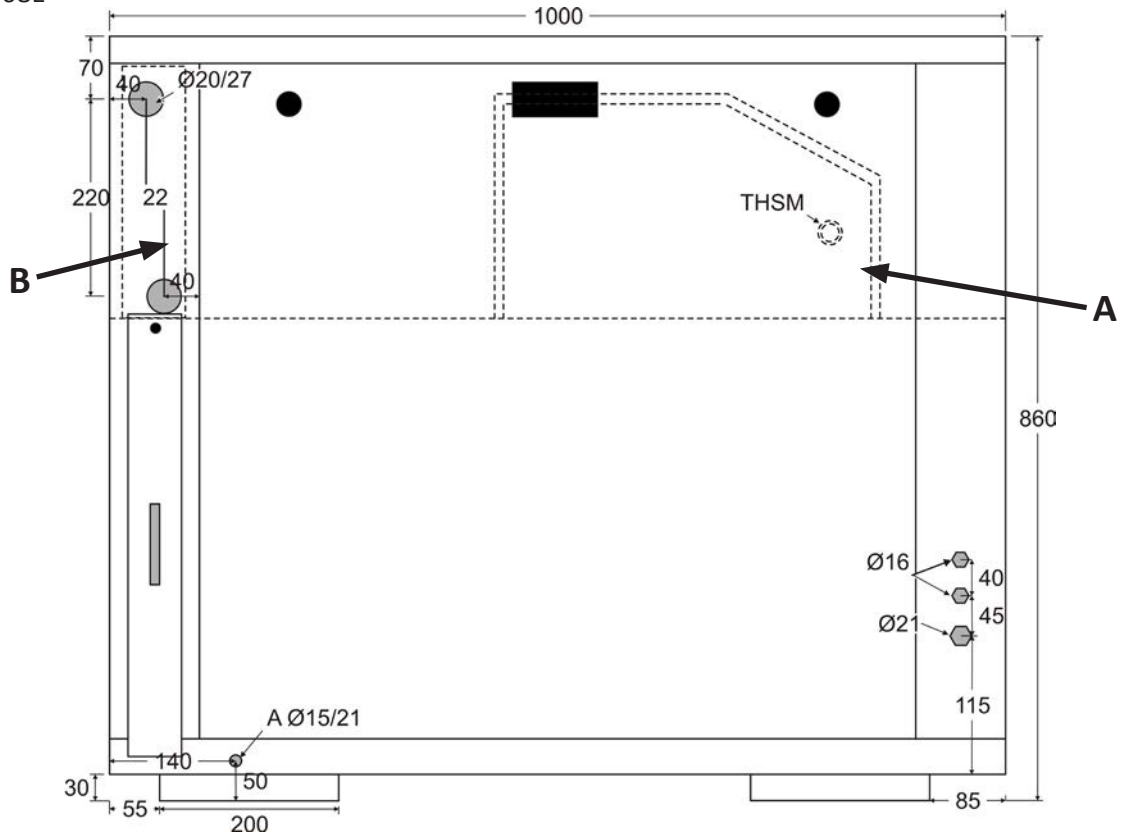

A : Back up heating
 Or
 B : Hot water battery

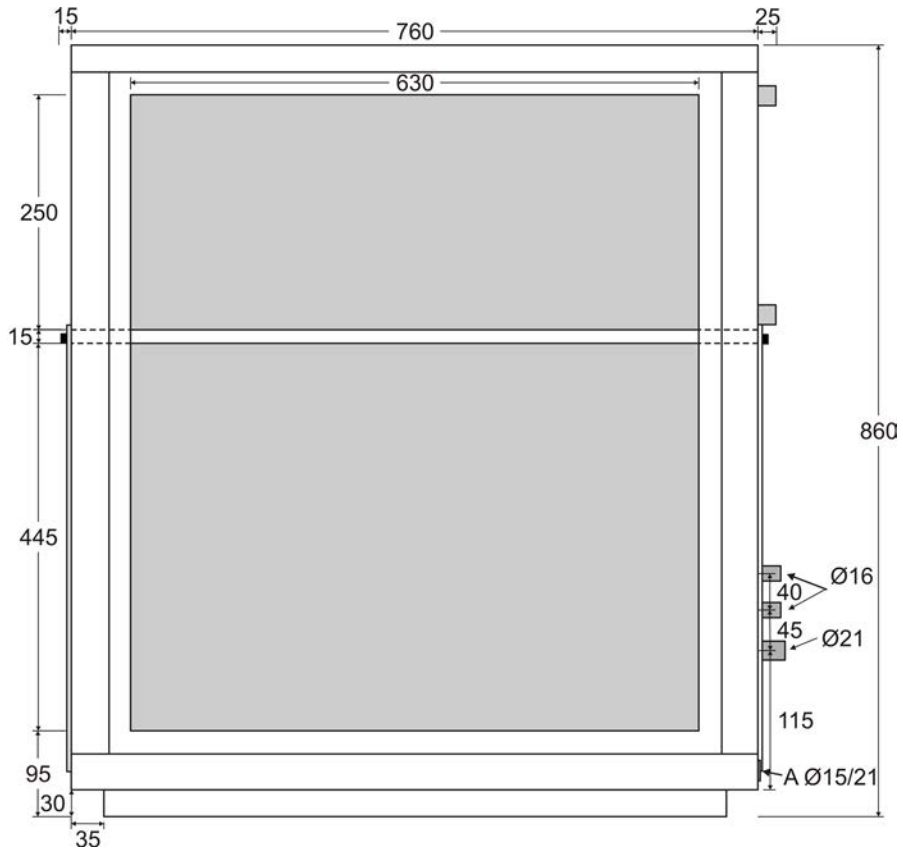



www.zodiac-poolcare.com

Pour plus de renseignements, merci de contacter votre revendeur.
For further information, please contact your retailer.

ZODIAC® is a registered trademark of Zodiac International, S.A.S.U., used under license.



Avec Ecofolio
tous les papiers
se recyclent.

Votre revendeur / your retailer

Zodiac Pool Care Europe - BP 90023 - 49180 St Barthélémy d'Anjou cedex - S.A.S.U. au capital de 1 267 140 € / SIREN 395 068 679 / RCS PARIS